

iovera^o

User Guide



Legal Notice

Caution: Federal Law (USA) restricts this device to sale by or on the order of a physician

This user guide is the proprietary material of Pacira Pharmaceuticals® or its affiliates and is protected by laws of copyright. The customers of the iovera® system are hereby granted limited, non-exclusive rights to use this user guide solely for the purpose of operating the iovera® system. Unauthorized copying, renting, modifying, or creating derivatives of this user guide is prohibited.

Information in this document is subject to change without notice.

Pacira Pharmaceuticals, Inc. DISCLAIMS ALL WARRANTIES, EXPRESSED OR IMPLIED, WITH RESPECT TO THE iovera® system (THE "PRODUCT"), INCLUDING BUT NOT LIMITED TO THOSE OF MERCHANTABILITY OR FITNESS FOR A PARTICULAR PURPOSE, TO THE FULLEST EXTENT ALLOWED BY LAW. IN NO EVENT SHALL Pacira Pharmaceuticals BE LIABLE FOR MISREPRESENTATION (OTHER THAN WHERE MADE FRAUDULENTLY) OR FOR ANY UNFORESEEABLE SPECIAL, INCIDENTAL, INDIRECT, PUNITIVE, MULTIPLE OR CONSEQUENTIAL DAMAGES IN CONNECTION WITH OR ARISING FROM THE PRODUCT, INCLUDING BUT NOT LIMITED TO THE USE THEREOF, WHETHER IN CONTRACT, TORT (INCLUDING BUT NOT LIMITED TO NEGLIGENCE), WARRANTY, OR UNDER ANY STATUTE OR ON ANY OTHER BASIS. NOTHING IN THE ABOVE SHALL EXCLUDE OR LIMIT LIABILITY FOR DEATH OR PERSONAL INJURY CAUSED BY THE NEGLIGENCE OF Pacira Pharmaceuticals.

Trademarks

The trademarks mentioned herein, including iovera® and Focused Cold Therapy®, are the property of Pacira Pharmaceuticals®.

All other trademarks are the sole property of their respective owners.

Patents

For information on Pacira Pharmaceuticals® patents and patents pending go to: <http://iovera.com/company/patents/>

Contents

Chapter 1 - Safety	4
Introduction	4
iovera ^o system Warnings and Cautions	4
Indications For Use.....	8
Intended User.....	8
Target Population	8
Contraindications	8
Potential Complications	8
Clinical Study, Osteoarthritis of the Knee	9
Chapter 2 – System Overview	11
iovera ^o system components	11
Glossary.....	13
Theory of Operation.....	14
Chapter 3 – Getting Started	16
iovera ^o System Set Up.....	16
iovera ^o Handpiece	17
Chapter 4 – Performing a Treatment Cycle.....	25
Setting up for a Treatment Cycle.....	25
Nerve Targeting	28
Removing the Cartridge	29
Reinstalling the Charging & Priming Tip.....	31
Cleaning the iovera ^o System	31
Handpiece Storage	32
Stopping a Cycle	32
Chapter 5 – System Warnings and Troubleshooting	34
Retrieving Device Log Files	34
Troubleshooting	35
Installation, Service, and Training	36
Appendix A – Guidance and Manufacturer’s Declaration	37
Appendix B – System Specifications.....	39
Appendix C – User Guide Addendum of Smart Tip	40



Chapter 1 - Safety

Introduction

Carefully read all instructions prior to using the iovera[®] system. Observe all contraindications, warnings, and cautions noted in this chapter and throughout the guide. Failure to do so may result in the possibility of injury to the patient or the operator, inferior treatment outcomes, or damage to the device.

iovera[®] system Warnings and Cautions

The following symbols and descriptions are found at appropriate places throughout this document.

 WARNING!	Indicates a hazardous situation which, if not avoided, could result in patient or user injury.
 CAUTION!	Indicates a hazardous situation, which, if not avoided, could result in equipment damage or malfunction.
NOTICE	Provides information that helps to maintain the highest iovera [®] system performance.

General Warnings

Warning	Description
Electrical	<p>The iovera[®] system may be hazardous if misused. Only connect the device to a proper mains power outlet, and use only the electrical adapter supplied by Pacira Pharmaceuticals. There are no user-serviceable parts in or on the iovera[®] system.</p> <p>The effects of interference from radio frequency identification (RFID) readers have not been studied on the iovera[®] system. The iovera[®] system is not recommended for use in close proximity to RFID readers.</p> <p>The iovera[®] system is not intended for use in a Magnetic Resonance Environment.</p> <p>The iovera[®] system needs special precautions regarding electromagnetic compatibility (EMC) and needs to be installed and put into service according to the EMC information provided in this manual.</p> <p>Portable and mobile radiofrequency (RF) communications equipment can affect the iovera[®] system.</p> <p>The use of accessories other than those specified by Pacira Pharmaceuticals may result in increased EMISSIONS or decreased IMMUNITY of the iovera[®] system.</p> <p>This iovera[®] system should not be used adjacent to or stacked with other equipment. If adjacent or stacked use is necessary, the iovera[®] system should be observed to verify normal operation in the configuration in which it will be used.</p>

	<p>In the rare event that a cooling cycle fails to stop, you must immediately remove the Handpiece Cap and loosen the Cartridge Cap to disengage the Cartridge, thus venting the cryogen.</p> <p>Danger: Explosion Hazard. Do Not Use in Presence of Flammable Anesthetics.</p>
iovera [®] System Components	<p>The iovera[®] system is intended for use only with the provided components. Substituting different components (cartridge, iovera[®] Smart Tip, electrical adapter for the charging dock, etc.) for those supplied by Pacira Pharmaceuticals may damage the device and/or create a hazard to the patient or the operator.</p>
Nitrous Oxide	<p>Nitrous oxide is an oxidizing agent that may accelerate combustion. DO NOT store cartridges near flammable materials or igniters. Store only where temperatures do not exceed 50 °C (122 °F).</p> <p>Nitrous oxide is under high pressure. A venting cartridge may dislodge with high force if removed from the handpiece. Allow system to depressurize completely before fully removing cartridge cap.</p> <p>Exercise caution when removing the cartridge as it may be very cold.</p>
iovera [®] Smart Tip	<p>The iovera[®] Smart Tip houses the closed-end needle array used to deliver the treatment.</p> <p>The iovera[®] system generates freezing temperatures that result in tissue destruction. The ends of the iovera[®] Smart Tip needles will reach subzero temperatures and could damage exposed tissues.</p> <p>Do not use an expired iovera[®] Smart Tip. Check the sterile package for expiration date.</p> <p>The iovera[®] system generates freezing temperatures that result in tissue destruction. The ends of the iovera[®] Smart Tip needles will reach subzero temperatures and could damage exposed tissues.</p> <p>Carefully inspect the iovera[®] Smart Tip package prior to use for any breach of the sterile barrier or damage to the contents. If the sterile barrier integrity is compromised or the contents are damaged, DO NOT USE and contact a Pacira Pharmaceuticals representative.</p> <p>The iovera[®] Smart Tip is sterile. Touching the iovera[®] Smart Tip needles may compromise sterility. The iovera[®] Smart Tip comes protected in the tip cap. DO NOT remove the tip cap until the system is ready to perform a cycle.</p> <p>The iovera[®] Smart Tip is single-patient-use. Do not reuse, reprocess or re-sterilize.</p>
Treatment	<p>Care should be taken when selecting the target treatment site. Treatment outside the intended target area could result in loss of motor function or unintended freezing of surrounding structures.</p> <p>Minimize any movement of the handpiece once the Smart Tip is in place and the cooling cycle has started. Excessive movement with the Smart Tip in place could result in damage to subcutaneous tissue.</p> <p>Do not re-treat the same area immediately after a successful treatment cycle. Allow the skin to rewarm first to reduce the risk of skin injury.</p> <p>As applicable, ensure that the Smart Tip needles are fully inserted into the skin so that the skin warming feature is touching the skin. Failure to fully insert the Smart Tip may result in skin injury. See Supplemental Instructions For Use for details.</p>

Do not reposition or remove the Smart Tip if resistance is felt. This may indicate the cooling zone is still attached to the Smart Tip and moving the Smart Tip may result in damage to subcutaneous tissue.







Do not attempt to remove the Smart Tip from the patient while cooling is in process. Doing so could result in damage to subcutaneous tissue.











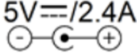



General Cautions

Caution	Description
iovera [®] System	<p>Carefully read all instructions prior to using the iovera[®] system. Observe all contraindications, warnings and cautions noted in this chapter and throughout the guide. Failure to do so may result in the possibility of injury to the patient or the operator, subpar treatment outcomes, or damage to the device.</p> <p>Do not place the handpiece into the charging dock without a Charging & Priming Tip. The handpiece may not stay in place in the charging dock without a Charging & Priming Tip attached, which may result in failure to charge the battery.</p> <p>Never submerge the iovera[®] handpiece or the charging dock into any liquids.</p> <p>Do not allow liquids or particulates into the cartridge chamber. Doing so could block nitrous oxide flow and prevent or limit cooling.</p>

Symbols

The following symbols are associated with the iovera[®] system.

Symbol	Description
	This marking on a product is a manufacturer's declaration that the product complies with the essential requirements of the relevant European health, safety, and environmental protection legislation.
	For Single Use Only; Do Not Reuse.
	Sterilized Using Ethylene Oxide. The iovera [®] Smart Tip is sterilized.
	Lot Number
	Serial Number
	Catalog Number
	Contains electronics. Dispose according to local regulations or return to Pacira Pharmaceuticals.

	<p>5 Volt Direct Current, 2.4 Amps. Cylindrical connector with positive center.</p>
	<p>User must follow Instructions for Use (this guide).</p>
	<p>Use By Date</p>
	<p>Storage Temperature Limitation</p>
	<p>Date of Manufacture</p>
	<p>Legal Manufacturer</p>
	<p>Consult Operating Instructions (this guide).</p>
	<p>Caution</p>
	<p>Do Not Use if Package is Damaged</p>
	<p>Type BF Applied Part (designation for medical devices that come into contact with a patient)</p>
	<p>Cartridge</p>
	<p>iovera® Smart Tip</p>
	<p>RF Transmitter</p>
	<p>MR Unsafe. Product is unsafe for use in a magnetic resonance environment.</p>
	<p>Prescription Only</p>

Indications For Use

The iovera^o system is used to destroy tissue during surgical procedures by applying freezing cold. It can also be used to produce lesions in peripheral nervous tissue by the application of cold to the selected site for the blocking of pain. It is also indicated for the relief of pain and symptoms associated with osteoarthritis of the knee for up to 90 days. The iovera^o system is not indicated for treatment of central nervous system tissue.

The iovera^o system's "1x90" Smart Tip configuration (indicating one needle which is 90 mm long) can also facilitate target nerve location by conducting electrical nerve stimulation from a separate nerve stimulator.

Intended User

The iovera^o system is intended for use by, or under the direction of, a physician.

Target Population

The iovera^o system is intended to treat adults.

The iovera^o system, when used for the relief of pain and symptoms associated with osteoarthritis of the knee, is intended for patients with Kellgren-Lawrence grade II or grade III osteoarthritis of the knee. The effects of the iovera^o treatment in patients with Kellgren-Lawrence grade IV osteoarthritis of the knee have not been studied, nor have the effects of repeated treatments. Cryoneurolysis with the iovera^o system has not been associated with secondary neuritis or neuroma formation in prior clinical experience¹, and there is no evidence that repeat cryoneurolysis treatments cause long-term changes to nerve function or structure².

Contraindications

The iovera^o system is contraindicated for use in patients with the following:

- Cryoglobulinemia
- Paroxysmal cold hemoglobinuria
- Cold urticaria
- Raynaud's disease
- Open and/or infected wounds at or near the treatment site

Potential Complications

As with any surgical treatment that uses needle-based therapy and local anesthesia, there is potential for site-specific reactions, including but not limited to:

¹ Ilfeld, Brian. Novel cryoneurolysis device for the treatment of sensory and motor peripheral nerves. Expert Review of Medical Devices (2016) Vol 13, No 8 713-725.

² Hsu M, Stevenson FF. Wallerian degeneration and recovery of motor nerves after multiple focused cold therapies. Muscle Nerve. 2015; 51 (2):268-275.

- Bruising (ecchymosis)
- Swelling (edema)
- Inflammation and/or redness (erythema)
- Local pain and/or tenderness
- Altered sensation (localized dysesthesia)

Proper use of the device as described in this User Guide can help reduce or prevent the following complications:

- Injury to the skin related to application of cold or heat
- Hyper- or hypo-pigmentation at the treatment site
- Skin dimpling at the treatment site
- Loss of motor function outside the target area

Typically, these reactions, if experienced, will resolve with no physician intervention. Patients may help the healing process by applying ice packs to the affected sites, and by taking over-the-counter analgesics.

Clinical Study, Osteoarthritis of the Knee

A multi-center, prospective, randomized, double-blind, sham-treatment controlled trial enrolling 180 subjects was conducted in subjects diagnosed with Grade II or III osteoarthritis of the knee (Kellgren-Lawrence classification grading scale) and washed out of all pain medication. A local anesthetic was used to create a diagnostic block of the infrapatellar branch of the saphenous nerve, as assessed by a 50% decrease in VAS pain upon standing from a seated position or walking up stairs, to confirm that the subject was a candidate for treatment.

121 subjects were treated with the iovera[®] system and 59 subjects were treated with a sham device, with ages ranging from 36 to 75 years. Data from all 180 subjects enrolled were collected and analyzed. The primary endpoint (superiority of the iovera[®] treatment over sham treatment for reducing pain and symptoms due to osteoarthritis in the knee as assessed by the Total Western Ontario and McMaster Universities Osteoarthritis Index (WOMAC) scale from baseline to Day 30) was met, $p=0.001$, see Table below. Subjects treated with the iovera system reported substantially more pain and symptom relief as subjects treated with the sham device (55% improvement versus 33% improvement, respectively).

Secondary endpoints were also met, including statistically significant superiority of iovera[®] treatment over sham treatment for relief of pain and symptoms due to osteoarthritis of the knee on the Total WOMAC scale (pain, stiffness, function) at Day 60 and a statistically significant number of patients reported clinically significant pain relief (30% reduction in WOMAC pain score) through 90 days after treatment with the

iovera[®] system, as shown in the table below.

		iovera[®] treatment group (n=121)	Sham control group (n=59)
Reduction in pain and symptoms on Total WOMAC scale 30 days post-treatment		-73.31 ¹	-42.18
Percentage of patients reporting 30% improvement in pain and symptoms on Total WOMAC scale post-treatment	30 days	74.58%	44.83%
	60 days	76.79%	56.90%
	90 days	80.18%	54.39%

LS Means and p-value were obtained by fitting an ANCOVA model with treatment as factor and WOMAC baseline score as a covariate.

There were no serious device-related or procedure-related adverse events. All device-related adverse events were as anticipated per the device labeling. A summary of adverse reactions, including site-specific reactions and/or known effects from cryoanalgesia that lasted longer than 30 days follows.

Adverse reaction	iovera (n=121)	Sham (n=59)
Numbness	18 (14.8%)	1 (1.7%)
Tenderness upon palpation	14 (11.6%)	8 (13.6%)
Local pain	8 (6.6%)	4 (6.8%)
Altered sensation/ localized dysesthesia	3 (2.5%)	2 (3.4%)
Tingling	3 (2.5%)	1 (1.7%)
Swelling	3 (2.5%)	3 (5.1%)
Bruising	3 (2.5%)	2 (3.4%)
Itching	2 (1.6%)	0
Vasovagal response	1 (0.8%)	0
Knee pain	1 (0.8%)	2 (3.4%)
Redness/inflammation	1 (0.8%)	1 (1.7%)
Pain, aggravated	0	1 (1.7%)

100% of subjects were subjected to a diagnostic lidocaine block to ensure that patients with an appropriate evaluation were enrolled in the study.

Chapter 2 – System Overview

iovera^o system components

Handpiece with Charging & Priming Tip and Cap	Charging Dock
	
iovera ^o Smart Tip and Tip Cap	Cartridge
	
Electrical Adapter ("Charger")	
	<div style="border: 1px solid black; padding: 10px;">  <p style="margin-left: 20px;">WARNING!</p> <p style="margin-left: 20px;">Use only the electrical adapter ("Charger") that is supplied with the iovera^o system. DO NOT attach any other type of electrical adapter to the iovera^o charging dock. Doing so may damage the device and/or potentially create a hazard to the patient or the operator.</p> </div>

Handpiece with iovera[®] Smart Tip (Expanded View)

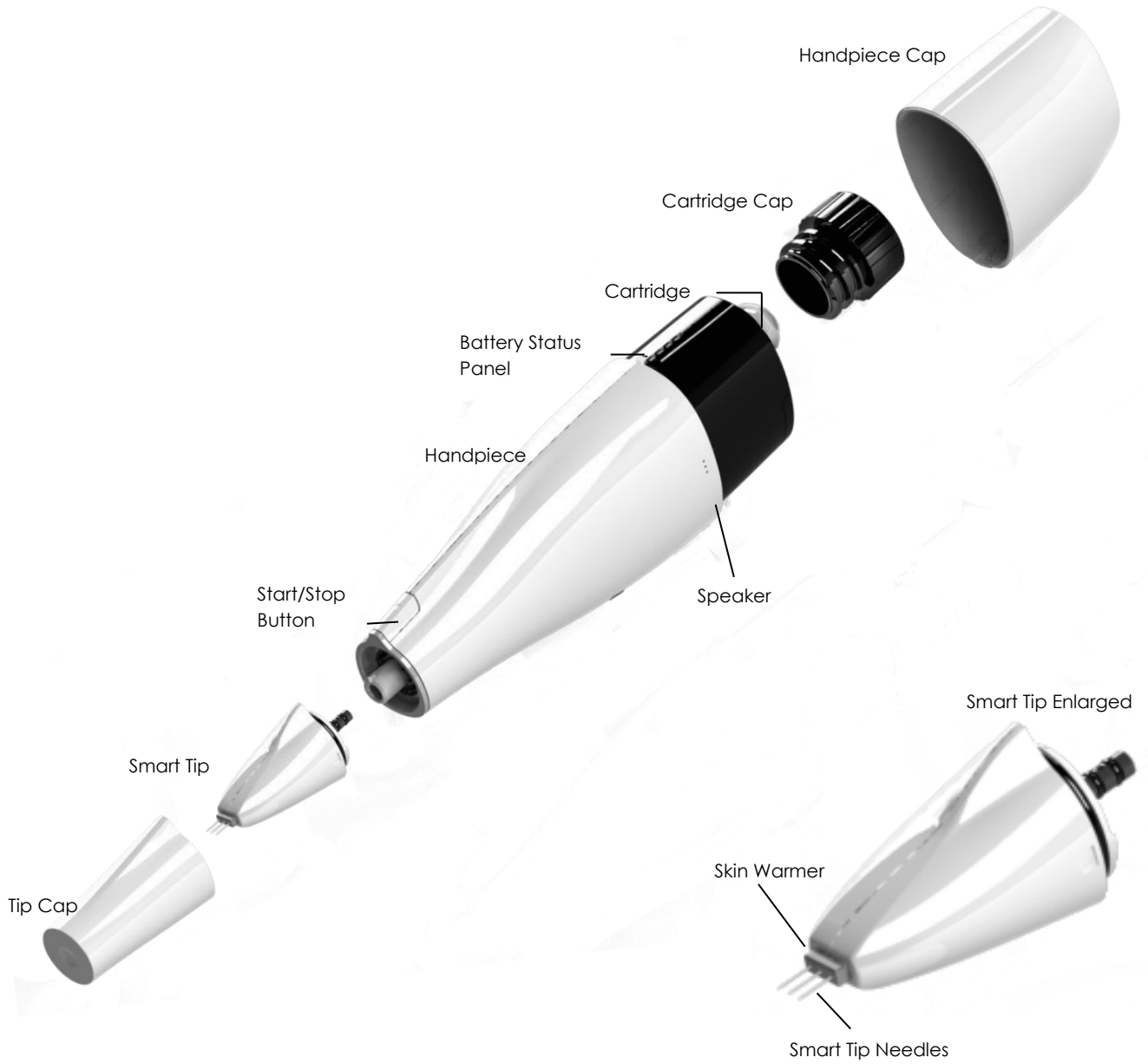

Glossary

The terms and acronyms used in this guide are listed in the table below.

Term or Acronym	Description
Battery Status Panel	The LED indicators located on the front of the handpiece to display current battery charge level.
Cartridge	A small pressurized canister containing liquid nitrous oxide.
Cartridge Chamber	The space inside the handpiece where the N ₂ O cartridge is placed.
Cooling Cycle	A single cryoanalgesia application using the iovera [®] system on a single site on a patient. Several cooling cycles at different sites equal one treatment.
Charging Dock	The stand used to hold the handpiece, which includes an electrical charger and electrical adapter.
Handpiece	A non-sterile, reusable, handheld device designed to control the flow of refrigerant from a disposable cartridge into an iovera [®] Smart Tip to cool target tissues.
LED/LEDs	Light emitting diode/light emitting diodes.
LED Blinking	LED turns completely on and off repeatedly.
LED Pulse/Pulsing	LED gradually dims and then brightens repeatedly.
LED Solid	LED is continuously illuminated.
Start/Stop Button	Button located on the handpiece that is used to start and to stop a cooling cycle; the button may also be used to perform other functions.
Preparation (Prep) Cycle	A special cycle that must be performed with some iovera [®] Smart Tips before each treatment.
Priming Sequence	A special sequence of cycles that must be performed at the beginning of each day before performing any treatments.
Reset Access	Located underneath the handpiece cap, this is an area that provides access to perform an iovera [®] system restart.
Charging & Priming Tip	A special tip used for system storage, charging, and priming cycles. Save it for reuse.
Refrigerant	A substance used to produce low temperatures. The iovera [®] system uses nitrous oxide (N ₂ O).
Skin Warmer	A plate located at the base of the needles on the iovera [®] Smart Tip that is designed to keep the skin surface warm during a treatment. The needles must be fully inserted for the skin warmer to be effective.
Smart Tip	The sterile tip that attaches to the end of the handpiece in order to deliver a treatment.
System Status Panel	The LED indicators located on the back of the handpiece that provide information about the treatment cycle.
Treatment	Multiple cooling cycles administered to different sites on a single patient.
Tip Cap	Protective cap that fully covers an iovera [®] Smart Tip or Charging & Priming Tip. Tip caps are also used to stabilize the handpiece while in the charging dock.

Theory of Operation

The Pacira Pharmaceuticals[®] iovera[®] system is a handheld device that enables the use of closed-end needles (called Smart Tips) to treat the targeted peripheral nerves for a particular application. Cryoneurolysis has been well established as a successful and preferred non-toxic method of tissue destruction, while keeping the surrounding tissue structures intact. The iovera[®] consumables include nitrous oxide cartridges and single-patient-use iovera[®] Smart Tips.

During a patient treatment, the iovera[®] Smart Tip needles are inserted into the target tissue and liquid nitrous oxide (N₂O) is delivered from a pressurized cylinder at >850 psi through a control valve and into the closed-end needles of the iovera[®] Smart Tip. Within each closed-end iovera[®] Smart Tip needle, the liquid nitrous oxide flows to the tip through an inner channel (lumen).

A combination of rapid pressure decrease and evaporation of the nitrous oxide causes an endothermic event that rapidly draws heat from the surrounding tissue, thus causing focused cooling at the point of the inserted iovera[®] Smart Tip needles. The focused cooling can reach temperatures below -20 °C (-4 °F). By incorporating a skin warmer, the iovera[®] system focuses precise subdermal cooling while protecting the skin.

The iovera[®] Smart Tip closed-end needles leave nothing in the patient's body. The gas created from the evaporating N₂O is vented back up through the needle and released harmlessly into the atmosphere.

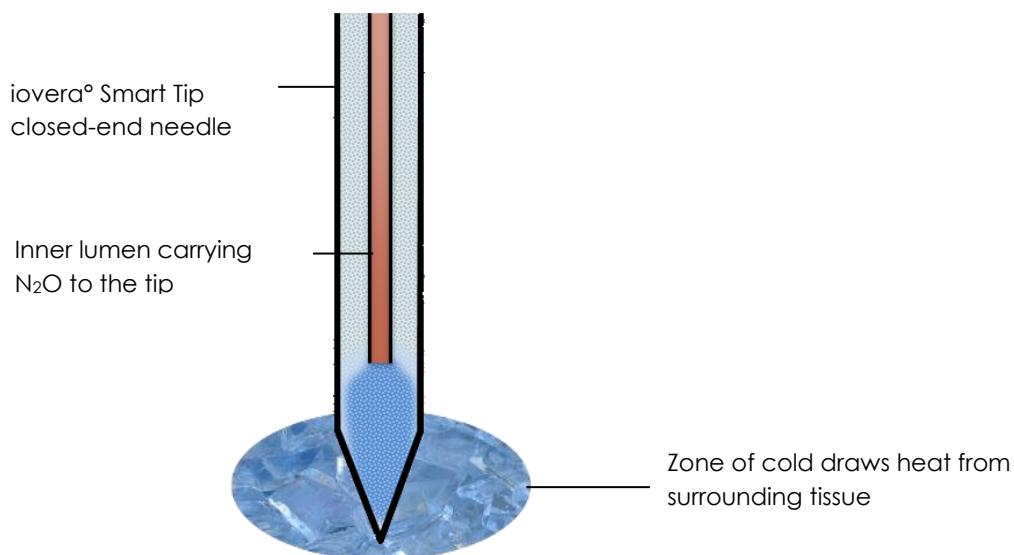

Sensors within the iovera[®] handpiece monitor the automated delivery of nitrous oxide and the rate of cooling to ensure consistency during treatment cycles.

When applied to nervous tissue, this freezing power is known as cryoneurolysis; freezing along the nerve axon causes distal disintegration of the axon and breakdown of the myelin sheath, while keeping the endoneurium and other connective tissue elements intact, which helps the nerve to re-grow along its original pathway. Lesioning of the nerve axon at the point of contact with the iovera[®] Smart Tip needle end is caused by rapid freezing at or below -20°C (-4°F). The rapid freeze causes mechanical and osmotic stresses which disrupt the tissue within the freezing zone and create axonal discontinuity that results in an immediate cessation of nerve signaling. Subsequently, the distal segment of the axon and myelin sheath degenerate (through the process known as Wallerian Degeneration). The endoneurium, epineurium, and perineurium remain intact, allowing subsequent regeneration of the nerve. Cryoneurolysis has not been associated with secondary neuritis or neuroma formation in prior clinical experience.³

³ Trescot, Andrea M. *Cryoanalgesia in an Interventional Pain Management Setting. Pain Physician. 2003;6:345-360.*

Chapter 3 – Getting Started

iovera^o System Set Up

- 1** Plug charger cable into base of charging dock.

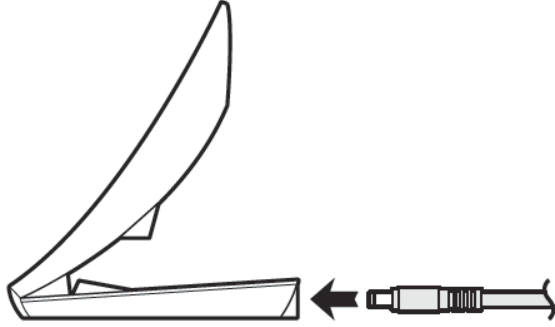

- 2** Plug adapter into outlet.

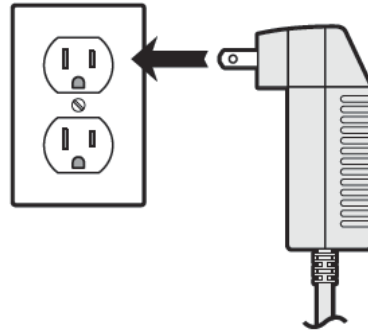

- 3**
Charge handpiece

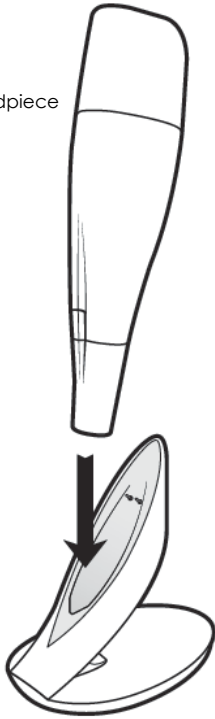

- 4**
Install cartridge;
Perform a priming .

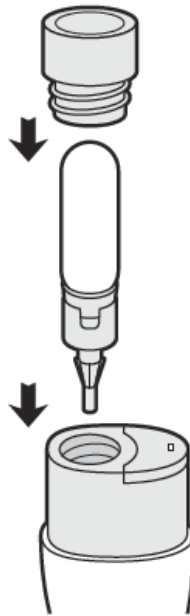

- 5**
Attach capped
iovera^o Smart Tip.

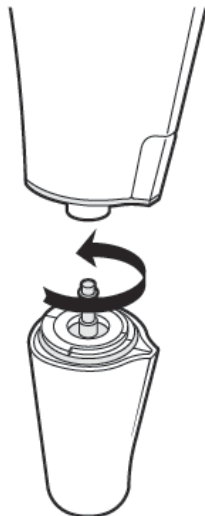

- 6**
Perform prep cycle (see
page 25).

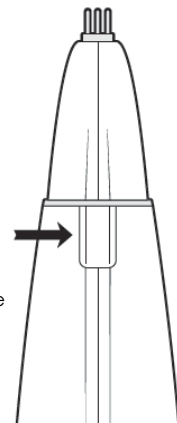

iovera^o Handpiece

The iovera^o handpiece is the control system that facilitates the transfer of nitrous oxide to the connected iovera^o Smart Tip in order to enable treatment. The illustrations on the next two pages highlight the essential components of the handpiece. To ensure that it is ready for use, always place the handpiece into the charging dock when it is not in use.



CAUTION!

Do not place the handpiece into the charging dock without a Charging & Priming Tip. The handpiece may not stay in place in the charging dock without a Charging & Priming Tip attached, which may result in failure to charge the battery.

NOTICE

Although the iovera^o system arrives partially charged, the amount of charge at delivery may vary. It is recommended that at least three solid blue LEDs  display in the Battery Status Panel before using the handpiece for the first time.

Handpiece Components: Expanded View

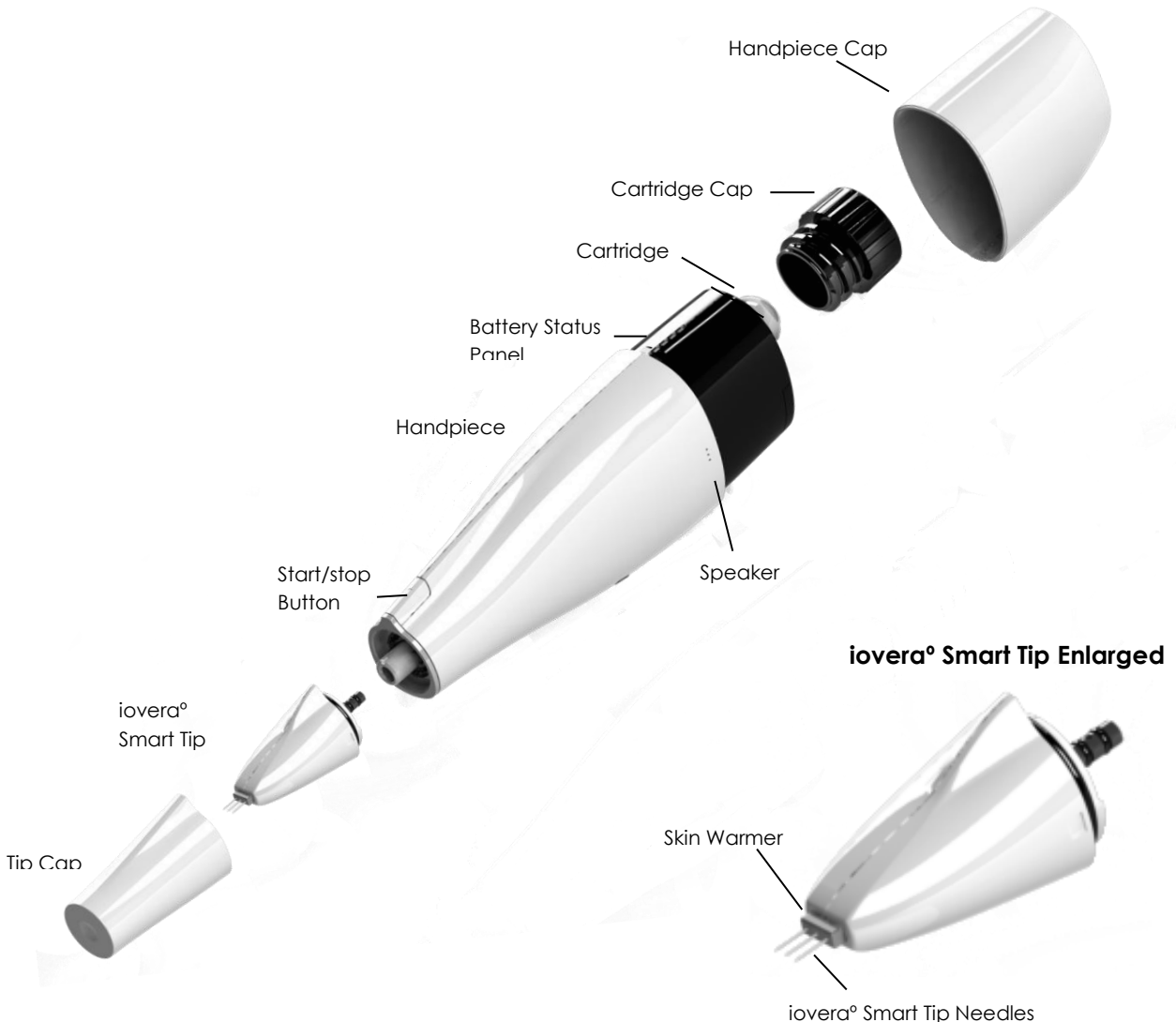

Handpiece Components: Expanded Top View

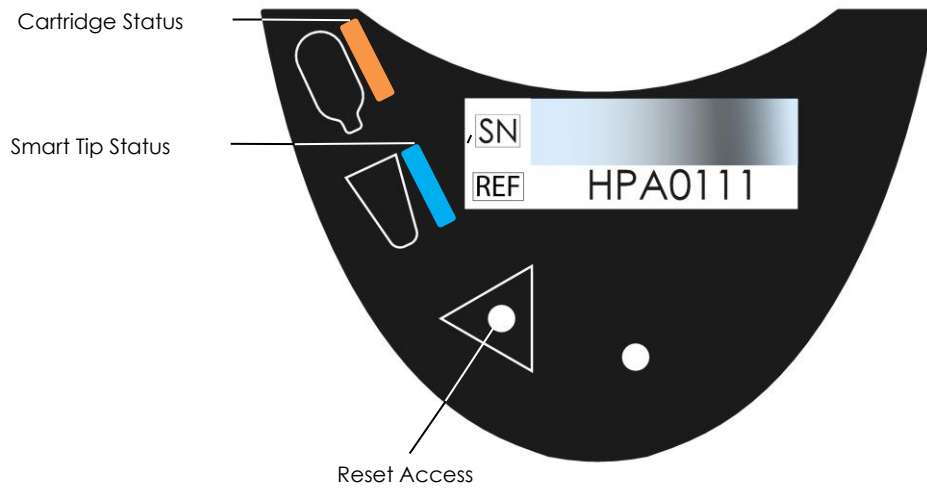
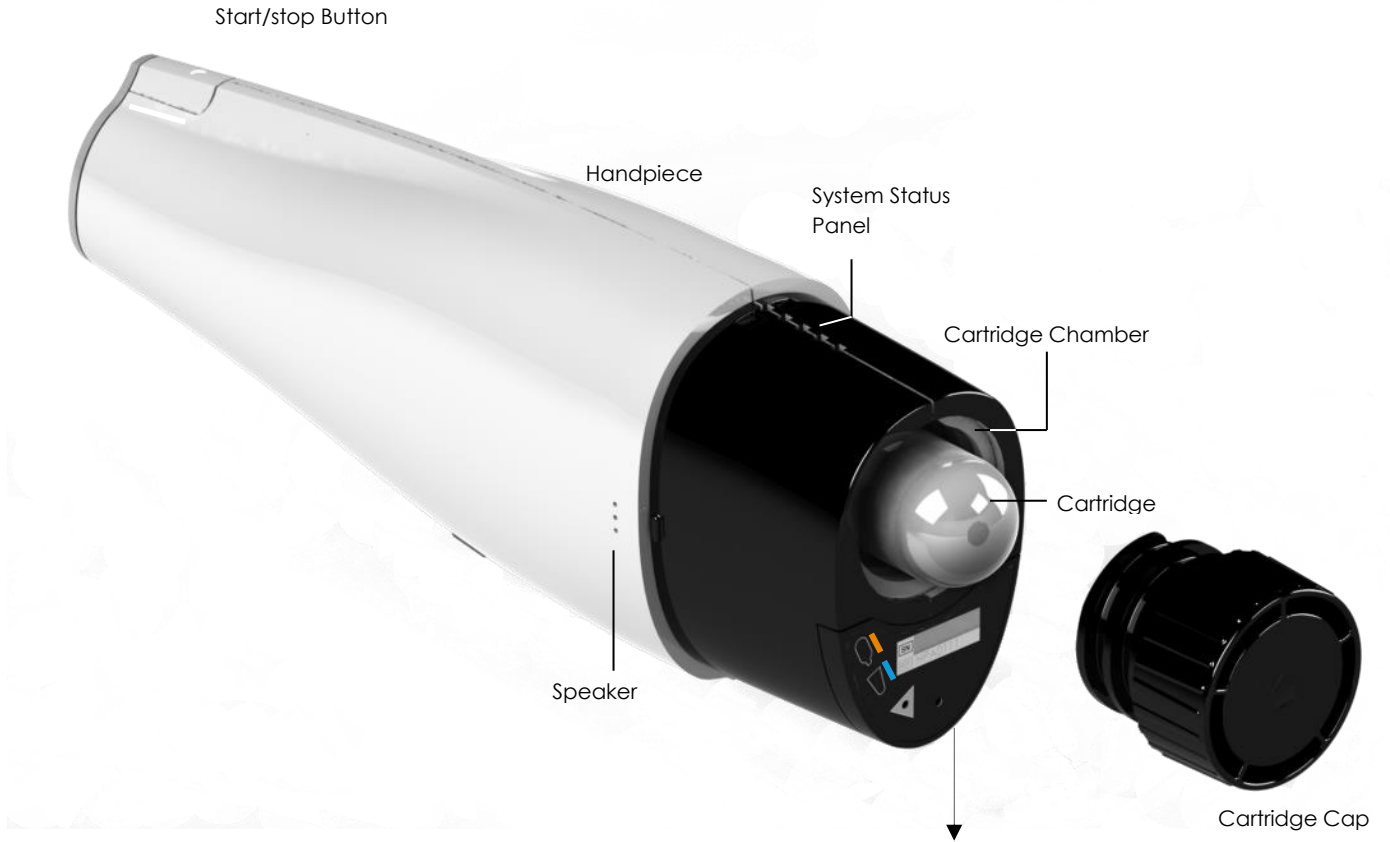

Status Indicator Lights

Integrated light emitting diode (LED) indicators are an integral component of the iovera[®] system.

LEDs indicate the various states of the iovera[®] handpiece. LEDs are located as follows:

- *Battery Status* is displayed on the front of the handpiece (the side with the start/stop button).
- *Handpiece Preparation Status* is displayed at the top of the handpiece, under the cap.
- *Treatment Status* and *System Status* are displayed on the rear of the handpiece.

The following illustrations do not include an iovera[®] Smart Tip.

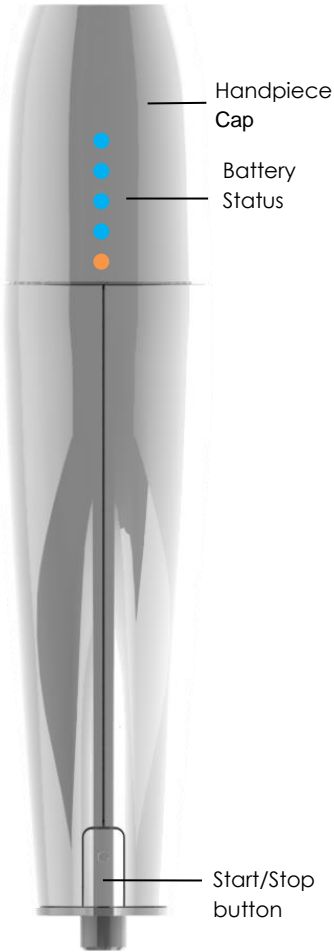
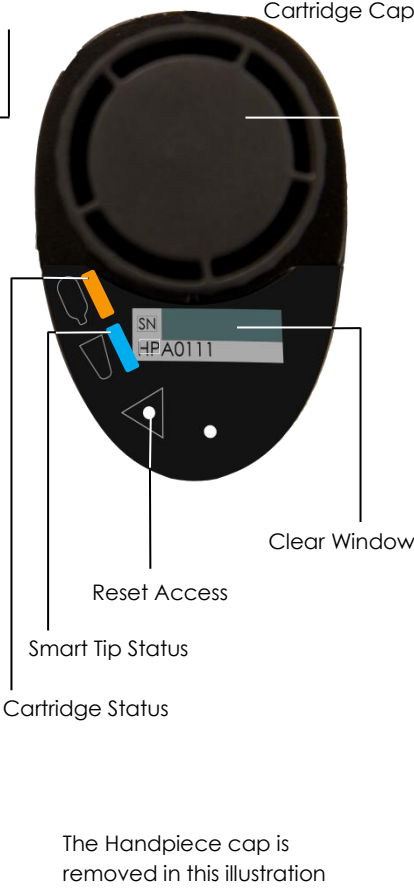
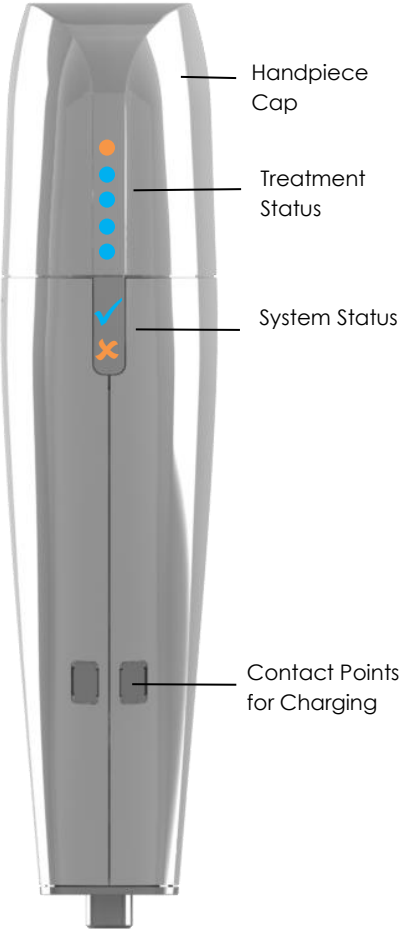
Front: Battery Status LED Panel	Top: Handpiece Preparation Status LED Panel	Rear: Treatment Status LED Panel and System Status LED Panel
 <p>Handpiece Cap</p> <p>Battery Status</p> <p>Start/Stop button</p>	 <p>Cartridge Cap</p> <p>SN HPA0111</p> <p>Clear Window</p> <p>Reset Access</p> <p>Smart Tip Status</p> <p>Cartridge Status</p> <p>The Handpiece cap is removed in this illustration</p>	 <p>Handpiece Cap</p> <p>Treatment Status</p> <p>System Status</p> <p>Contact Points for Charging</p>
<p>Front: Battery Status</p>	<p>Top: Handpiece Preparation Status</p>	<p>Rear: Treatment Status and System Status</p>

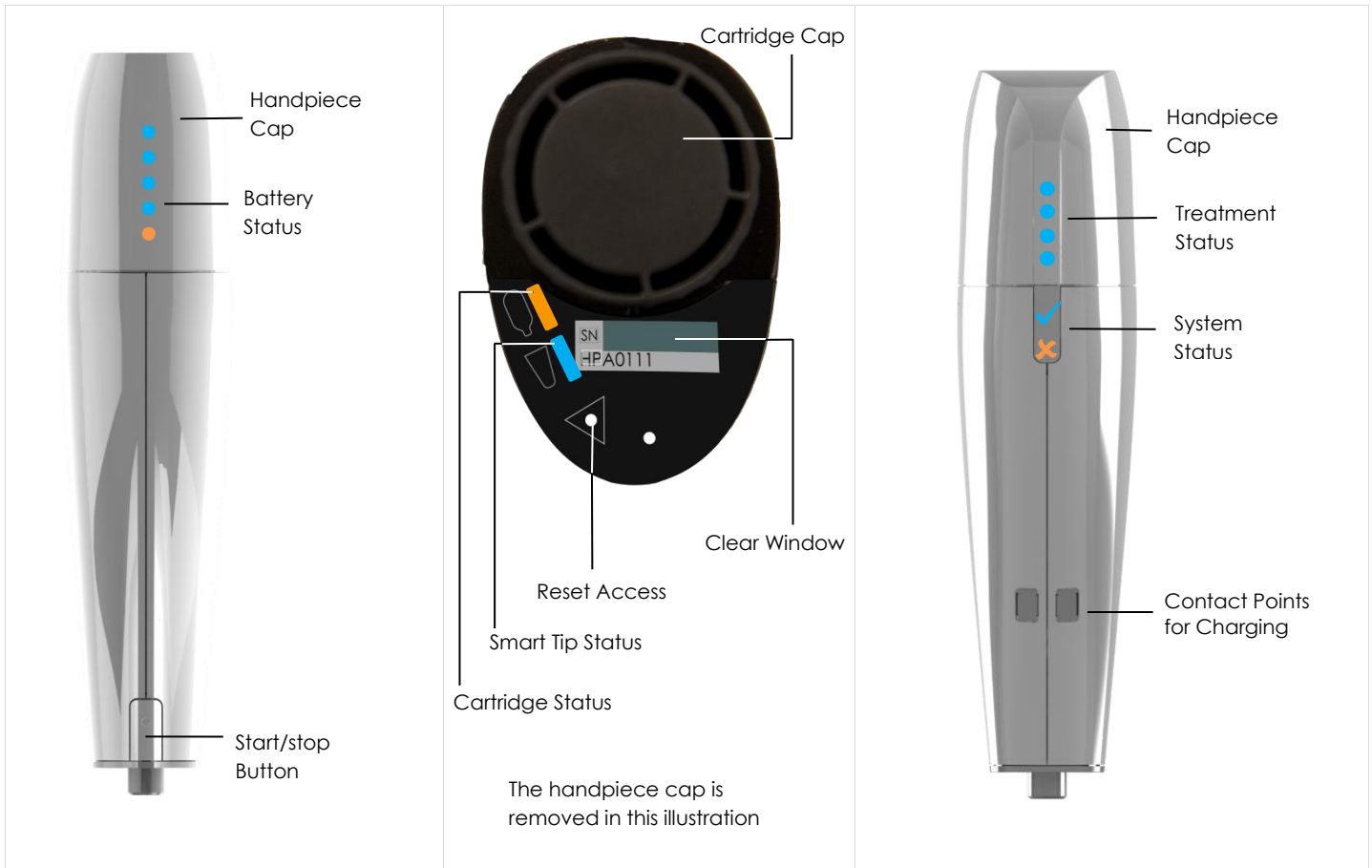







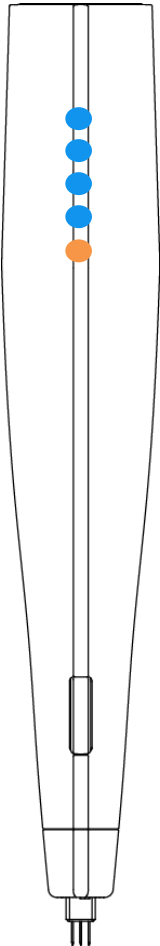

The colors and behaviors of the LEDs provide consistent visual feedback of the handpiece status.

- Blue LED (●):** Device is ready to use or has successfully completed an operation.
- Orange LED (●):** Device has encountered an error or requires user attention.

LED	Denotes
Solid Blue ●	The device is ready.
Pulsing Blue ●●●●	A function is in process.
Solid or Blinking Orange ● ☀	A system component is not functioning properly or has failed; user attention is required.







Front Panel: Battery Status

The LEDs on the front of the handpiece indicate how much battery power is available.

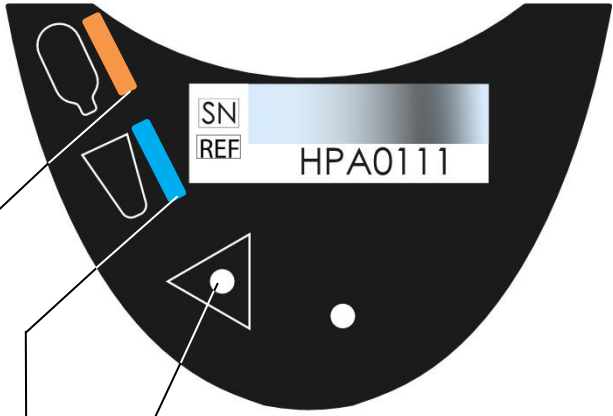



LED Color	Battery Status (while positioned on charging dock)	Front View LED Configuration
 Solid Blue	Charging is complete. The battery has a full charge.	
 Pulsing Blue	Handpiece is charging and has sufficient power to perform at least one cycle. (The number of pulsing Blue LEDs indicate the charge level of the battery).	
 Pulsing Orange	Handpiece is charging and has insufficient power to perform a cycle.	
LED	Battery Status, OFF Charging Dock (Approximations)	
	4 Solid Blue: Full charge (80-100%)	
	3 Solid Blue: Medium charge (65-79%)	
	2 Solid Blue: Medium charge (45-64%)	
	1 Solid Blue: Low charge (30-44%) Sufficient charge to perform at least one cycle.	
	Solid or blinking Orange: Low charge (<30%) Return Handpiece to the charging dock.	

Preparation Status (Top): Cartridge and Smart Tip Status Indicators







Slide the top cover up to remove it from the iovera[®] handpiece. This will reveal two rectangular LED indicators next to the cartridge status icon and the iovera[®] Smart Tip status icon.

LED	Cartridge Status	Top View LED Configuration
 Solid Blue	Ready to use.	 <p>Reset Access</p> <p>Smart Tip Status</p> <p>Cartridge Status</p>
 Pulsing Blue	Cartridge is warming. Wait until LED becomes solid blue before proceeding.	
 Blinking Orange	Replace the cartridge.	
LED	Smart Tip Status	
 Solid Blue	Ready for use.	
 Pulsing Blue	Checking the Smart Tip.	
 Blinking Orange	Replace the Smart Tip	

System Status (Rear)

LED	System Status	
 Solid Blue Check Mark	Indicates one of the following depending on what has been performed: <ul style="list-style-type: none"> • Prep or prime is complete and system is ready for use. • Treatment cycle is complete and Smart Tip is ready to be removed from the patient. 	
 Solid Orange Check Mark	Indicates one of the following depending on what has been performed: <ul style="list-style-type: none"> • Prime or Prep cycle did not pass; repeat Prime or Prep cycle. • Prep cycle needed. <p>See the section, <i>Handpiece Control Features</i>, for instructions on how to initiate a Prep cycle.</p>	
 Orange X	The device is connected to a computer via its USB interface. Do not initiate a treatment cycle.	

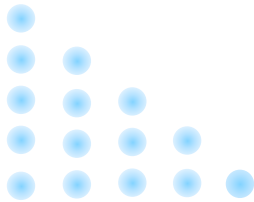
Treatment Status (Rear)

LED	Treatment Status	Rear View LED Configuration
 Solid Orange LED	Device should be primed before using. (See: Performing a Priming Sequence).	
 Blinking Orange LED	Device needs to be primed. Attach Charging & Priming Tip, change cartridge and Performing a Priming Sequence .	
 Solid Blue LEDs	System is ready for use.	
 Pulsing Blue LEDs	<p>Cycle in process.</p> <p>At the start of the cycle, the five blue LEDs will pulse. As the cycle progresses, the number of pulsing LEDs will decrease. This indicates time elapsed during the cycle. When the cycle is complete, the check mark will appear and it is safe to remove the smart tip.</p> <p>The entire sequence takes ~60 seconds, depending on the programmed cycle length.</p>	
 Blinking 1 st , 3 rd , and 5 th Blue LEDs	<p>Canceling cycle.</p> <p>When a cycle has been canceled, the 1st, 3rd, and 5th blue LED will begin to blink. Once the blue LEDs stop blinking and a check mark appears, it is safe to remove an inserted iovera[®] Smart Tip from the patient.</p>	
LEDs not illuminated	<p>System not ready.</p> <p>Check the cartridge and Smart Tip status indicators at the top of the handpiece before continuing.</p>	
 All Blue and Orange LEDs alternately blinking	<p>An unrecoverable error has occurred.</p> <p>Refer to the troubleshooting section of this guide for more information.</p>	



WARNING!

Do not attempt to remove an inserted iovera[®] Smart Tip from a patient while the treatment is in process. Doing so could result in damage to subcutaneous tissue.

Handpiece Control Features

Functions using the start/stop button on the front of the iovera[®] handpiece are described below.

Event	Action Description
Start a Cycle	<p>Press and release the start/stop button once.</p> <div data-bbox="355 464 1442 533" style="border: 1px solid black; padding: 5px;"> <p>NOTICE A cycle can only be initiated if the system detects an acceptable iovera[®] Smart Tip, cartridge, and sufficient battery charge.</p> </div>
Stop a Cycle	<p>Press and release the start/stop button once.</p> <p>Wait for the cycle to complete (a blue check mark appears) before withdrawing the needles from the patient.</p> <div data-bbox="378 726 1430 842" style="border: 1px solid black; padding: 5px;"> <div style="display: flex; align-items: center;">  <p>WARNING! Do not attempt to remove an inserted iovera[®] Smart Tip from a patient while the treatment is in process. Doing so could result in damage to subcutaneous tissue.</p> </div> </div>
Standby Mode	<p>Remove cartridge if present. Press and hold the start/stop button for 3 seconds to place the system in standby mode.</p> <div data-bbox="355 942 1442 1041" style="border: 1px solid black; padding: 5px;"> <p>NOTICE The iovera[®] handpiece is shipped in standby mode. Also, when the handpiece has been unused for more than 20 minutes, the handpiece enters standby mode.</p> </div>
Wake Device from Standby Mode	<p>When the handpiece is in standby mode, press and hold the start/stop button for 5 seconds to wake.</p> <p>The system will also wake from standby mode when placed into the dock.</p>

Press the start/stop button on the small, circular indentation, as shown below.

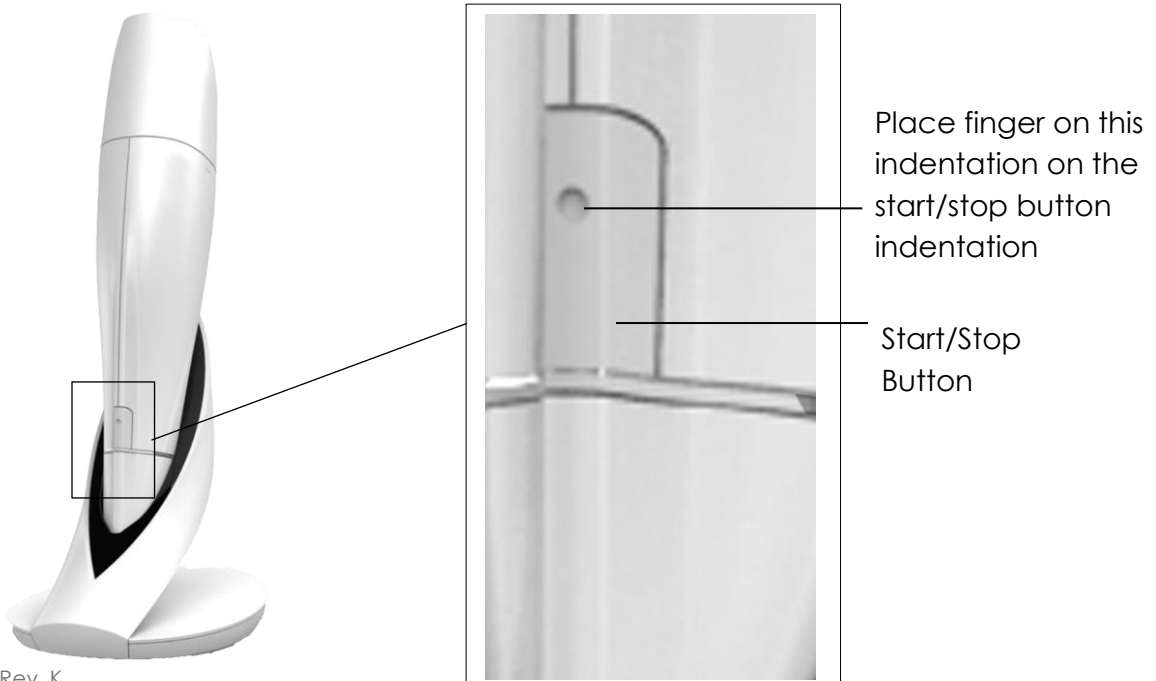

Chapter 4 – Performing a Treatment Cycle

Setting up for a Treatment Cycle

Before initiating a treatment, ensure that:

- The iovera[®] system is clean and disinfected.
- For treatments performed in a sterile environment, the user should take the appropriate measures to assure the handpiece is properly covered with a sterile barrier.

	WARNING!	Do not use any components if their packaging appears damaged.
	WARNING!	Physician discretion should be exercised when patient presents with existing neuromuscular disease compromising the regeneration of peripheral nerves that may be involved in the treatment.

Installing a Cartridge

1. Remove the handpiece cap and set it aside.
2. Remove the cartridge cap.
3. Insert a new cartridge into the handpiece and screw the cartridge cap over it, ensuring the threads are fully tightened.
4. Wait until the blue LED next to the cartridge symbol changes from pulsing to solid (see figure below).
5. Place the handpiece cap back onto the handpiece.

NOTICE

After inserting a cartridge, quickly secure the cartridge cap to minimize leakage. Excess nitrous oxide leakage may reduce the number of available cycles provided by a cartridge.

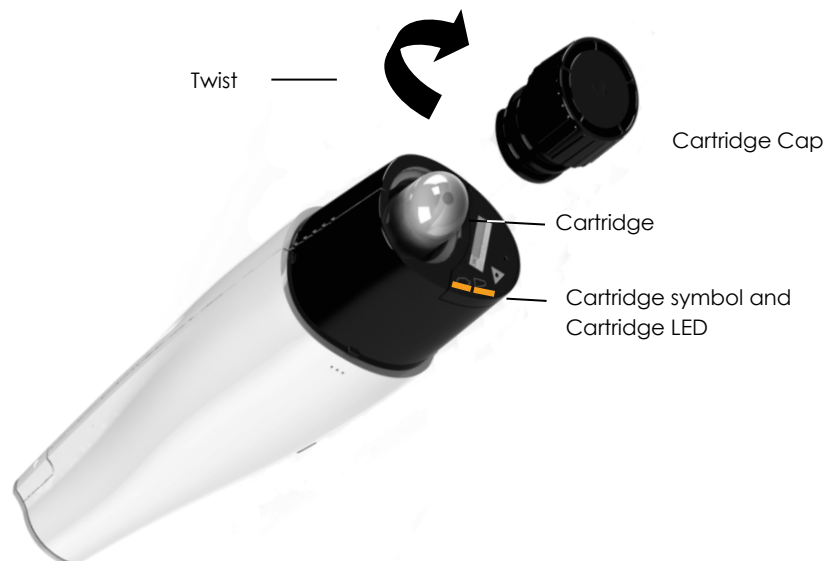

NOTICE

In order to ensure optimum performance, a cartridge will expire after being in the handpiece for more than three hours.

Performing a Priming Sequence

1. A sequence of priming cycles must be performed one hour or less prior to the first patient of the day **or** if it has been more than one hour since the last use. The need to perform a priming sequence may also be indicated by an orange light on the rear of the device (see [figure](#) for reference).
2. If the Charging & Priming Tip is not already installed, twist the Charging & Priming Tip onto the handpiece as shown below.
3. Ensure the molded ridge on the Charging & Priming Tip aligns with the molded ridge on the handpiece.

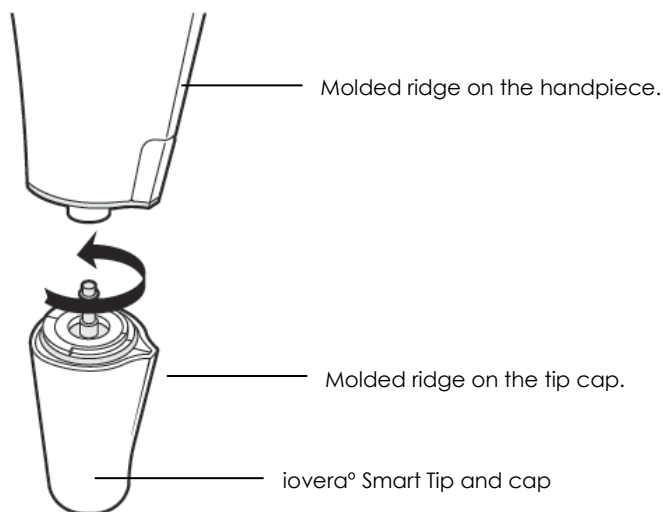

4. Hold the handpiece so that the Charging & Priming Tip points down (toward the floor). Press and release the start/stop button to begin the priming sequence.
5. Priming cycles will continue to run until the handpiece is fully primed (6 cycles). The status indicator lights will all be steady blue, the blue checkmark will display, and the orange prime indicator light will turn off.

Once you have confirmed that the priming sequence is completed and the cartridge is expended, replace the cartridge and begin treatment.

NOTICE

The Priming sequence should be performed within one hour of the first procedure of the day or if it has been more than one hour since the last cycle. The orange light on the rear of the device will indicate the need to prime.

Removing the Charging & Priming Tip

1. Unscrew the Charging & Priming Tip and remove it from the handpiece.
Save the Charging & Priming Tip for future priming cycles and device storage/charging.

Installing the iovera^o Smart Tip

1. If installed, unscrew the Charging & Priming Tip from the handpiece.
2. Remove the iovera^o Smart Tip from the sterile package, and screw it firmly into the handpiece.
3. Ensure that the ridge on the Smart Tip cap aligns with the ridge on the handpiece.
4. Do not remove the smart tip cap until you are ready to use the iovera^o Smart Tip.
5. Perform a prep cycle if required (see supplemental Smart Tip instructions for details).



WARNING!

Carefully inspect the iovera^o Smart Tip package prior to use for any breach of the sterile barrier or damage to the contents. If the sterile barrier integrity is compromised or the contents are damaged, DO NOT USE and contact a Pacira Pharmaceuticals representative.

Performing a Prep Cycle

Certain iovera^o Smart Tips require a prep cycle to be performed before beginning a treatment (see supplemental Smart Tip instructions for details). If the device has not yet been primed, complete a prime sequence then perform a prep cycle. Ensure the molded ridge on the Charging & Priming Tip aligns with the molded ridge on the handpiece. Leave the tip cap in place.

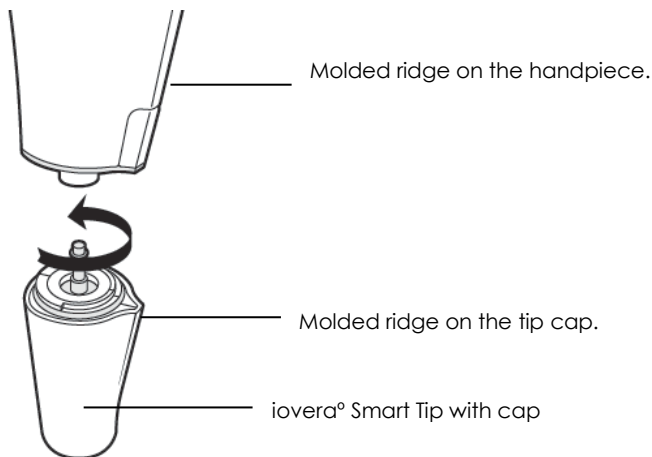

1. Hold the handpiece so that the iovera^o Smart Tip points up (toward the ceiling)
2. Press and release the start/stop button to begin the prep cycle.
3. A blue check mark displays on the rear of the handpiece when the prep cycle is complete.

Nerve Targeting

In applications where the nerve must be located without the aid of direct visualization and/or where the use of anatomical landmarks requires additional confirmation, a separate off-the-shelf nerve stimulator device may be used to identify the target nerve.



WARNING!

When using a nerve stimulator, follow the Instructions for Use (IFU) for that device, and observe all warnings, cautions, and precautions.

A diagnostic nerve block can also be administered to confirm that treatment of the targeted nerve will provide the desired pain relief. This is accomplished by injecting anesthetic along the targeted nerve superficially to block nerve conduction.

Inserting the iovera[®] Smart Tip into the Target Site



WARNING!

The iovera[®] Smart Tip is sterile. Touching iovera[®] Smart Tip needles may compromise sterility. The Smart Tip comes protected in a tip cap. DO NOT remove the tip cap until ready to perform a cycle.

1. Clean the treatment area with an alcohol wipe.
2. Confirm handpiece is ready to start a cycle by confirming Treatment Status LEDs are solid blue.
3. Remove the tip cap and discard.
4. Insert the iovera[®] Smart Tip into the target treatment site.



WARNING!

Care should be taken when selecting the target treatment site. Treatment outside the intended target area could result in loss of motor function or unintended freezing of surrounding structures.

5. In applications where skin warming at the base of the iovera[®] Smart Tip is necessary (refer to tip-specific instructions), ensure that the needles are fully inserted into the skin so that the skin warmer is touching the skin (See the illustration in the section, *Handpiece Components: Expanded View*).



WARNING!

Failure to insert the iovera[®] Smart Tip sufficiently may result in skin injury in percutaneous applications.

6. Ensuring that the handpiece is vertical or near-vertical, press and release the start/stop button once to begin the cooling cycle. A tone sounds when the cycle begins.



WARNING!

Minimize any movement of the handpiece once the iovera[®] Smart Tip is in place and the cooling cycle has started. Excessive movement could result in damage to subcutaneous tissue.

**WARNING!**

Do not attempt to remove the iovera[®] Smart Tip from the patient while the cooling is in process. Doing so could result in damage to subcutaneous tissue.

- Once the five blue Treatment Status LEDs stop pulsing on the rear of the handpiece, a check mark LED will display and a tone will sound, indicating that the cycle is complete. At this time, the iovera[®] Smart Tip may be removed from the treatment site and, if desired, repositioned at a different site for another treatment cycle.

**WARNING!**

For percutaneous application, do not to treat the same site more than once within 10 minutes. This allows the skin to warm and reduces risk of skin injury.

- When the treatment is complete, remove the iovera[®] Smart Tip from the patient.

**WARNING!**

Do not reposition or remove the iovera[®] Smart Tip if there is any resistance. This may indicate that the cooling zone is still attached to the iovera[®] Smart Tip, which may result in damage to subcutaneous tissue if moved.

- Carefully unscrew and remove the used iovera[®] Smart Tip from the handpiece and place it into a sharps container.
- Attach the Charging & Priming Tip.
- Clean the iovera[®] handpiece (see the section, *Cleaning the*).
- Clean the charging dock, if necessary (see the section, *Cleaning the Charging Dock*).
- Remove the cartridge, then re-attach the cartridge cap.
- Slide the handpiece cap onto the handpiece.
- Return the handpiece to the charging dock.

Removing the Cartridge

NOTICE

A 'pop' and/or 'hissing' may be heard as the cartridge cap is unscrewed. This sound signals that the cartridge has successfully disengaged from the handpiece and is venting nitrous oxide.

- Remove the handpiece cap from the handpiece and set it aside.
- Hold the handpiece with the tip pointing down.
- Slowly and partially unscrew the cartridge cap until the system makes a hissing or popping noise, indicating that the system has begun to release nitrous oxide.
- Wait 45 seconds to allow the system to depressurize completely (venting is no longer audible) before removing the cartridge cap.
- Still holding the handpiece with the tip pointing down, remove the cartridge cap while pointing the cartridge towards a safe location, away from the user, patient, or bystanders.

**WARNING!**

Nitrous oxide is under high pressure. A venting cartridge may dislodge with high force if removed from the handpiece. Allow system to depressurize completely before fully removing cartridge cap.

**CAUTION!**

Exercise caution when removing the cartridge.

6. Firmly grasp the cartridge and remove from the handpiece.
 - If nitrous oxide continues to vent from the cartridge:
 - Point the black filter down towards the floor and away from bystanders.
 - Firmly hold the cartridge and allow the nitrous oxide to vent completely (use gauze to insulate against cold if necessary).
7. Discard the cartridge once nitrous oxide is no longer exiting from the cartridge.
8. Dispose of the used cartridge following local requirements and protocols.

NOTICE

Always remove the cartridge after completing treatments. If the cartridge is left in the handpiece for more than one hour, the cartridge will expire. Replace the cartridge prior to performing a treatment.

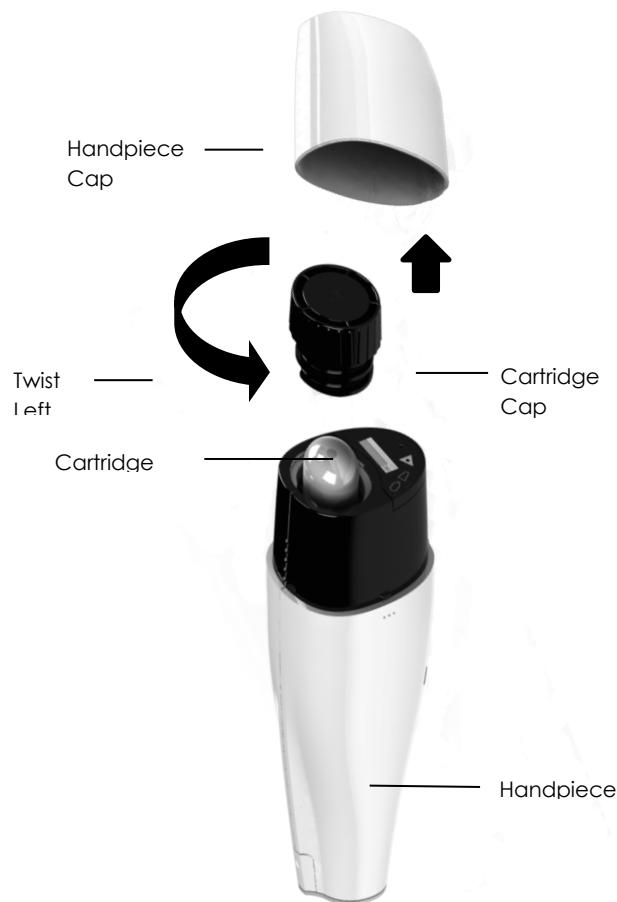

Reinstalling the Charging & Priming Tip

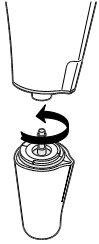

1. Screw the Charging & Priming Tip onto the handpiece as shown below.
2. Ensure the molded ridge on the Charging & Priming Tip aligns with the molded ridge on the handpiece.
3. Do not remove the Charging & Priming Tip cap.

Cleaning the iovera^o System

The iovera^o system is a reusable cryoneurolysis device and must be thoroughly cleaned and disinfected after each patient use.

To clean the handpiece (with the Charging & Priming Tip and tip cap in place):

- Remove contaminants with clean, pre-saturated 70% isopropyl alcohol (IPA) wipes. Repeat with new wipes until the device is clean.

NOTICE

It is important that the handpiece be cleaned immediately after each patient use. Cleaning immediately after use helps prevent accumulation of contaminants.



CAUTION!

- Never submerge the iovera^o handpiece or the charging dock into any liquids.
- Never use compressed air on, around, or in the iovera^o handpiece.
- Do not allow liquids or particulates into the cartridge chamber. Doing so could block nitrous oxide flow and prevent or limit cooling.

Detailed Instructions for Cleaning the Handpiece

Thoroughly cleaning the iovera^o handpiece involves:

- Removal of conspicuous contamination. Inspect for any obvious signs of contamination (e.g. blood or other fluids, dirt/debris, other obvious contaminants).
- Using clean, pre-saturated 70% IPA wipes, vigorously scrub the contaminated areas until the contamination is removed. Repeat as required using a new clean wipe.
- Limit scrubbing to conspicuously contaminated areas to reduce the possibility of spreading contaminants around the device.

- Pay special attention to these areas on the handpiece:
 - Small gaps and lines on the outer handpiece shell.
 - Gaps around the start/stop button.
 - Gaps/recesses around the LEDs.
 - Ribs on the cartridge cap.
- To ensure maximum disinfection, utilize sufficient, fresh isopropyl alcohol to ensure that all surfaces remain damp for approximately 5 minutes.
- Discard soiled wipe and obtain a new wipe as required.
- Wipe gently and limit scrubbing to minimize abrasions on the handpiece.

When complete, return handpiece to charging dock and allow to air dry for at least five minutes prior to next use.

Cleaning the Charging Dock

Use the same material and techniques described above to clean the charging dock.

Handpiece Storage

1. If treatment is complete and if you are done using the cartridge for the day, remove it and discard (see the section, *Removing the Cartridge*).
2. Screw the cartridge cap into the handpiece.
3. Slide the handpiece cap into position on the handpiece.
4. Attach the Charging & Priming Tip to the handpiece.
5. Return the handpiece to the charging dock.

Stopping a Cycle



WARNING!

Do not reposition or remove the iovera[®] Smart Tip if there is any resistance. This may indicate that the cooling zone is still attached to the iovera[®] Smart Tip, which may result in damage to subcutaneous tissue if moved.

In the event that a cooling cycle must be terminated before the pre-programmed cycle is complete, press and release the start/stop button on the handpiece to terminate the cycle. Stopping a cycle may take a short time to complete in order to ensure safe removal of the iovera[®] Smart Tip.



WARNING!

It is imperative that you wait until the system signals that it is safe to remove the iovera[®] Smart Tip before doing so:



- a. The blue Treatment Status LEDs on the back of the handpiece stop pulsing.
- b. A check mark LED displays on the back of the handpiece.
- c. A tone sounds as the cycle completes.

Once the check mark displays and the tone sounds, it is safe to remove the iovera[®] Smart Tip from the treatment area.

Performing an Emergency Cycle Stop

In the rare event that a cooling cycle fails to terminate, the cooling cycle may be stopped by removing the handpiece cap and loosening the cartridge cap until the cartridge vents. This depressurizes the system, ending cooling. Do not remove the cartridge cap until venting has completed.

Be aware that a 'pop' or 'hissing' sound may be heard when the cartridge disengages; this is an expected behavior indicating that nitrous oxide is no longer flowing to the iovera[®] Smart Tip.

	WARNING!	Do not reposition or remove the iovera [®] Smart Tip if there is any resistance. This may indicate that the cooling zone is still attached to the iovera [®] Smart Tip, which may result in damage to subcutaneous tissue if moved.
	WARNING!	Nitrous oxide is under high pressure. A venting cartridge may dislodge with high force if removed from the handpiece. Allow system to depressurize completely before fully removing cartridge cap.

Chapter 5 – System Warnings and Troubleshooting

In the event that the iovera[®] system detects an unfavorable condition, an orange check mark will illuminate on the rear of the handpiece. In this case, check the cartridge and tip status indicators for more information. Check the Troubleshooting section of this guide for additional information.

Retrieving Device Log Files

For faster resolution to product support issues, device log files may be required.

To access these files:

1. Remove access cover

- Start with powered handpiece (wake by holding button or placing on dock)
- Remove handpiece cap
- Insert paperclip into hole as shown, push down and slide out to remove access cover



2. Connect micro USB cable

- Attach the micro USB cable to the handpiece and the computer
- Wait a few moments for device drivers to appear on your computer
 - PC: When prompted, click “Open folder to view files”
 - MAC: “Myoscience” drive appears on desktop

3. Send log files

- Go to <http://www.iovera.com/logfileupload>
- Complete the required fields
- Click “Upload a File” button
- Locate the drive or device labeled “Myoscience”
- Select and attach both EVENT.DAT and PERIODIC.DAT
- Click “Submit”

4. After the files are uploaded and the form is sent, you may remove the cable, replace the access cover and handpiece cap, and return the handpiece to the charging dock.

Troubleshooting

The following table contains instructions for basic troubleshooting actions. In the event device malfunctions persist or malfunctions occur beyond those described below, users should not attempt to repair the device. Contact Pacira Pharmaceuticals Customer Service for guidance.

Issue	Possible Solution
Handpiece LEDs are not on	Place handpiece into the charging dock and check the battery status panel to ensure it has a sufficient battery charge. If issue persists, contact product support at 1-800-442-0989.
Cycle won't start / treatment status LEDs are not on	Check cartridge and Smart Tip indicators. Replace cartridge or Smart Tip as indicated. Then confirm that at least one blue LED on the battery status LED panel is illuminated. If issue persists, contact product support at 1-800-442-0989.
Cartridge status LED blinks orange at end of cycle with blue checkmark	<p>Replace cartridge; if issue persists, replace cartridge again and wait 5 minutes.</p> <p>If issue persists, place the handpiece on the dock for a few minutes to warm it up. After doing so, when the device is reset, the cartridge light should become blue again.</p> <p>If issue continues to persist, contact product support at 1-800-442-0989.</p>
Smart Tip status LED blinks orange	Reattach iovera [®] Smart Tip, ensuring guides on the tip and handpiece are aligned. If issue persists, clean handpiece tip contacts with IPA wipe and reattach. If issue persists, contact product support at 1-800-442-0989.
Cycle ends with orange check mark	<p>Check cartridge and Smart Tip indicators:</p> <ol style="list-style-type: none"> 1. If the cartridge status LED is blinking, replace cartridge. 2. If the Smart Tip LED is blinking, detach iovera[®] Smart Tip and reattach it. 3. Repeat the cycle at the last treatment location. <p>If issue persists, contact product support at 1-800-442-0989.</p>
Handpiece displays an unrecoverable error (all LEDs on the treatment status panel alternately blink orange and blue, continuously)	<ol style="list-style-type: none"> 1. Remove cartridge (if present) and iovera[®] Smart Tip; install Charging & Priming Tip. 2. Press and hold the start/stop button for 3 seconds to put the system into standby mode. 3. Place the system on the dock to wake from standby mode. 4. Insert a new cartridge. 5. Perform a priming sequence. 6. <p>If issue persists, contact product support at 1-800-442-0989.</p>
Battery status LED blinks orange	Low power – place system in dock to charge.
Handpiece won't charge or wake up while in dock	<p>Check dock power. Make sure a Charging & Priming Tip is attached to the handpiece and that charging contacts are oriented correctly making contact with dock power pins.</p> <p>If issue persists, perform a system reset by using a paperclip to press the reset access button located within the triangle at the top of the device (see iovera[®] Handpiece for illustration). Then place handpiece on the dock for 2-3 hours.</p> <p>If issue persists, contact product support at 1-800-442-0989.</p>
Cannot remove iovera [®] Smart Tip from tissue due to resistance (after waiting)	Loosen cartridge cap until the cartridge vents (depressurizes system, ending cooling). Do not remove the cartridge cap until venting is complete.
Handpiece is leaking cryogen (may hear hissing)	An object may be inadvertently lodged in the top of the handpiece. Remove the cartridge, flip the handpiece over so the needle end is pointed up, and lightly tap the handpiece over a white piece of paper or cloth to dislodge. Contact product support at 1-800-442-0989 with details.

Smart Tip status LED blinks orange after attaching the Charging & Priming Tip	Detach, then re-attach, the Charging & Priming Tip. If status indicator continues to blink orange, the Charging & Priming Tip may require replacement. Replace with spare Charging & Priming Tip and contact customer service for replacement.
Priming LED turns on at the end of a treatment cycle	Retreat last treatment site. If LED continues to be on after a second cycle, perform treatment cycles in air until it turns off, then continue with treatment.

Issue	Possible Solution
Cartridge status LED blinks orange after attaching Charging & Priming Tip.	<ol style="list-style-type: none"> 1. The Charging & Priming Tip requires a full cartridge to prime. 2. If continuing with treatment, replace the Charging & Priming Tip with treatment tip and continue to prime. 3. If priming is needed, replace cartridge, prime and then continue with treatment.
Cartridge status LED blinks orange after 3 hours	Cartridge is expired. Replace cartridge and continue with priming.
Three treatment status LEDs blink blue during treatment	The treatment cycle was cancelled (button was pressed or an error was detected). Wait until the checkmark appears to remove iovera [®] Smart Tip. Repeat treatment cycle.
Smart Tip status LED blinks orange after attaching the Charging & Priming Tip	Detach, then re-attach, the Charging & Priming Tip. If status indicator continues to blink orange, the Charging & Priming Tip may require replacement. Replace with spare Charging & Priming Tip and contact ioveraCS@icsconnect.com for replacement.

Installation, Service, and Training

Pacira Pharmaceuticals recommends that users charge the system until at least three blue LEDs display prior to first use. Training on the operation and specific techniques is provided by Pacira Pharmaceuticals, Inc., and/or your local distributor. See contact information on the back cover of this guide.

There are no user-serviceable parts in the iovera[®] system. Contact your local distributor for replacement parts.

Appendix A – Guidance and Manufacturer’s Declaration

Table 1
Guidance and Manufacturer’s Declaration – Electromagnetic Emissions

The iovera® system is intended for use in the electromagnetic environment specified below. The customer or the user of the iovera® system should assure that it is used in such an environment.

Emissions Test	Compliance	Comments
Conducted Emissions EN 55011:2009+A1:2010, CISPR 11:2009+A1:2010, FCC Part 15 Subpart B: 2011, ICES-003:2004, VCCI V-3/2011.04, BSMI CNS 13438:2006	Class B 150 kHz to 30 MHz	The iovera® system uses RF energy only for its internal function. Therefore, its RF emissions are very low and are not likely to cause any interference in nearby electronic equipment.
Radiated Emissions EN 55011:2009+A1:2010, CISPR 11:2009+A1:2010, FCC Part 15 Subpart B: 2011, ICES-003:2004, VCCI V-3/2011.04, BSMI CNS 13438:2006	Class B 30 MHz to 1 GHz	
Harmonic emissions IEC 61000-3-2	Per Clause 5 of the standard	
Voltage Fluctuations/ Flicker emissions	Per Clause 5 of the standard	

Table 2
Recommended separation distances between portable and mobile RF communications equipment and the iovera® system

The iovera® system is intended for use in an electromagnetic environment in which radiated RF disturbances are controlled. The customer or the user of the iovera® system can help prevent electromagnetic interference by maintaining a minimum distance between portable and mobile RF communications equipment (transmitters) and the iovera® system as recommended below, according to the maximum output power of the communications equipment.

Rated maximum output power of transmitter W	Separation distance according to frequency of transmitter m		
	150 kHz to 80 MHz $d = [3.5/\sqrt{P}]$	80 MHz to 800 MHz $d = [3.5/\sqrt{E1}]$	800 MHz to 2.5 GHz $d = [7/\sqrt{E1}]$
0.01	0.12	0.12	0.23
0.1	0.37	0.37	0.74
1	1.17	1.17	2.33
10	3.69	3.69	7.39
100	11.67	11.67	23.33

For transmitters rated at a maximum output power not listed above, the recommended separation distance d in meters (m) can be estimated using the equation applicable to the frequency of the transmitter, where P is the maximum output power rating of the transmitter in watts (W) according to the transmitter manufacturer.

NOTE 1: At 80 MHz and 800 MHz, the separation distance for the higher frequency range applies.

NOTE 2: These guidelines may not apply in all situations. Electromagnetic propagation is affected by absorption and reflection from structures, objects and people.

Table 3
Guidance and Manufacturer's Declaration – Electromagnetic Immunity

The iovera[®] system is intended for use in the electromagnetic environment specified below. The customer or the user of the iovera[®] system should assure that it is used in such an environment.

Immunity test	IEC 60601 test level	Compliance level	Electromagnetic environment – guidance
Electrostatic discharge (ESD) IEC/EN 61000-4-2	±2, 4, and 6 kV contact discharge ±2, 4, and 8 kV air discharge	±2, 4, and 6 kV contact discharge ±2, 4, and 8 kV air discharge	Floors should be wood, concrete or ceramic tile. If floors are covered with synthetic material, the relative humidity should be at least 30 %.
Radiated Immunity IEC/EN 61000-4-3	80 MHz - 2.5 GHz 3 V/m 80% @ 1 kHz	80 MHz - 2.5 GHz 3 V/m 80% @ 1 kHz	Portable and mobile RF communications equipment should be used no closer to any part of the iovera [®] system, including cables, than the recommended separation distance calculated from the equation applicable to the frequency of the transmitter. Recommended separation distance $d = (3.5 / E1) \sqrt{P}$ 80 MHz to 800 MHz $d = (7 / E1) \sqrt{P}$ 800 MHz to 2.5 GHz where P is the maximum output power rating of the transmitter in watts (W) according to the transmitter manufacturer and d is the recommended separation distance in meters (m). Conducted Immunity: $d = (3.5/V1) \sqrt{P}$ Field strength from fixed RF transmitters, as determined by an electromagnetic site survey, should be less than the compliance level in each frequency range. Interference may occur in the vicinity of equipment marked with the following symbol. 
Conducted Immunity (AC Power) (I/O Lines) IEC/EN 61000-4-6	0.15 - 80 MHz 3 Vrms 1 kHz AC Mains	0.15 - 80 MHz 3 Vrms 1 kHz AC Mains	Mains power quality should be that of a typical commercial or hospital environment.
Electrical Fast Transients (AC Power) IEC/EN 61000-4-4	±2 kV AC Mains ±1 kV I/O Lines 5/50 5 kHz	±2 kV AC Mains ±1 kV I/O Lines 5/50 5 kHz	Mains power quality should be that of a typical commercial or hospital environment
Surge Line to Line (AC Power) IEC/EN 61000-4-5	±1 kV Line to Line ±2 kV Line to Ground	±1 kV Line to Line ±2 kV Line to Ground	Mains power quality should be that of a typical commercial or hospital environment.
Magnetic Immunity IEC/EN-61000-4-8	3 A/m 50/60 Hz	3 A/m 50/60 Hz	Power frequency magnetic fields should be at levels characteristic of a typical location in a typical commercial or hospital environment.
Voltage Dips & Interruptions IEC/EN 61000-4-11	>95% dip in U_T^4 for 0.5 cycle 60% dip in U_T for 5 cycles 30% dip in U_T for 25 cycles >95% dip in U_T for 5 Sec	>95% dip in U_T for 0.5 cycle 60% dip in U_T for 5 cycles 30% dip in U_T for 25 cycles >95% dip in U_T for 5 Sec	Interruptions and dips in Mains voltage may cause prolonged charging cycles.

⁴ U_T is the AC mains voltage prior to application of the test level

Appendix B – System Specifications

Handpiece Mass:	250g (0.55 lbs.)
Charging Dock Mass:	225g (0.50 lbs.)
IPX0:	No protection against ingress of fluids
Type of Refrigerant Used:	Nitrous Oxide (N ₂ O)
Minimum /Maximum Internal Operating Pressure:	5650 to 6880 kPa (820 to 998 psi)
Power Requirements:	Input 100 - 240 VAC, 50/60 Hz, 0.35 – 0.15 A
Internal Battery (not serviceable):	3.7V 3100mAh
Serviceable Parts:	None
Manufacturer's Recommended Refrigerant Containers:	Only use Pacira Pharmaceuticals [®] provided refrigerant cartridges (iovera [®] Cartridges)
Manufacturer's Recommended Electrical mains adapters:	Only use Pacira Pharmaceuticals provided electrical mains adapter for the charging dock
Thermal Insulation:	Handpiece is designed to prevent excessive cooling and possible damage to the user
Electrical Isolation:	Type  BF Applied Part.

Operating, Storage, and Transit Conditions

	Operating	Storage and Transit
Temperature	10 to 30 °C (50 to 86 °F)	-20 to 50 °C (-4 to 122 °F)
Humidity	10 to 50% RH	10 to 85% RH
Pressure	55 to 103 kPa (8 to 15 psi)	55 to 103 kPa (8 to 15 psi)

Appendix C – User Guide Addendum of Smart Tip

Smart Tip (1X55mm Round)

User Guide Addendum
Smart Tip (1x55mm Round)

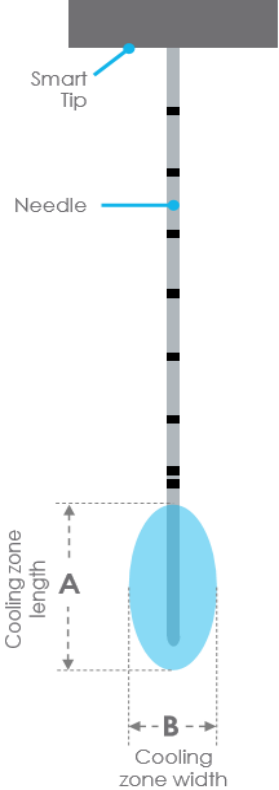

Smart Tip

Needle

Cooling zone length
A

Cooling zone width
B

h	mm (in)	
	A	B
STT0413	9.4 (0.37)	5.4 (0.21)

Dimensions are for information purposes only. They are based on 40-second cooling cycle performed in agarose gel. The ice ball size could vary based on anatomy/physiology of patients and should not affect the efficacy of treatment.

This document is provided as a supplement to the User Guide. Always refer to the User Guide for complete operating instructions, warnings and precautions.

⚠ WARNING! To reduce likelihood of skin injury, insert needle at least 15mm, denoted by last double marking ■.

⚠ CAUTION! Small bend radii may affect performance.

- Do not kink or permanently deform needle.
- 35mm minimum radius.

Procedure:

- Prep cycle not required for this tip type.
- Pre-pierce the skin before inserting Smart Tip.
- Insert needle to maximum insertion desired, then perform cooling cycle.
- Needle markings are at 6mm increments.

12300 Rev C

Smart Tip (3X6.9mm Sharp)

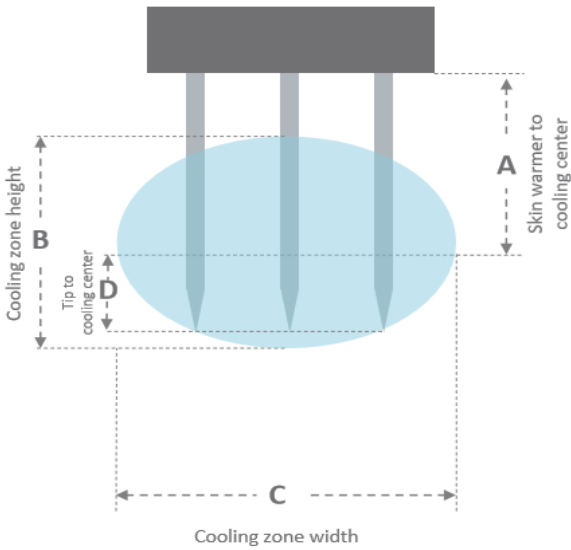

User Guide Addendum
Smart Tip (3X6.9mm Sharp)



h	mm (in)			
	A	B	C	D
STT0513	4.7 (0.19)	5.1 (0.20)	7.6 (0.30)	2.2 (.09)

Dimensions are for information purposes only. They are based on 35-second cooling cycle performed in agarose gel. The ice ball size could vary based on anatomy/physiology of patients and should not affect the efficacy of treatment

This document is provided as a supplement to the User Guide. Always refer to the User Guide for complete operating instructions, warnings and precautions.

-  **WARNING!** To reduce likelihood of skin injury, skin warmer must be pressed against the skin when the needle is inserted before running a treatment cycle.
-  **WARNING!** Needle may contact bone in low BMI patients. Patient anatomy should be assessed prior to tip selection.

Procedure:

- Prep cycle required for this tip type.

12301 Rev D

Smart Tip (1X90mm Sharp) with Nerve Stim

User Guide Addendum Smart Tip (1x90mm Sharp) with Nerve Stim

iovera^o

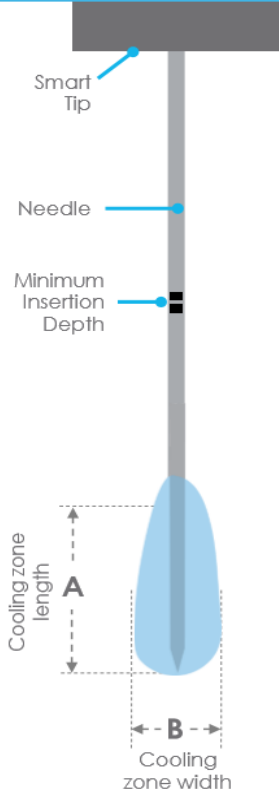

h	mm (in)	
	A	B
STT0811	16.0 (0.63)	7.1 (0.28)

Dimensions are for information purposes only. They are based on 60-second cooling cycle performed in agarose gel. The ice ball size could vary based on anatomy/physiology of patients and should not affect the efficacy of treatment.

This document is provided as a supplement to the User Guide. Always refer to the User Guide for complete operating instructions, warnings and precautions.

WARNING! To reduce likelihood of skin injury, insert needle at least 30mm, denoted by the double marking (labeled minimum insertion depth on the image) ■.

CAUTION! Small bend radii may affect performance.

- Do not kink or permanently deform needle.
- 55mm minimum radius.

Procedure:

- Prep cycle not required for this tip type.
- Pre-piercing of the skin may make Smart Tip insertion easier.
- Insert needle to maximum insertion desired, then perform cooling cycle.

Optional Nerve Stimulation

- This iovera^o Smart Tip is enabled to be connected to a separate off-the-shelf nerve stimulator via the port on the side of the Smart Tip using the cable provided.
- Please refer to manufacturer-specific instructions for that device and observe all warnings, cautions, and precautions should the user choose to use this optional feature.

12395 Rev C

Smart Tip (1X90mm Sharp)

iovera^o
User Guide Addendum
Smart Tip (1x90mm Sharp)

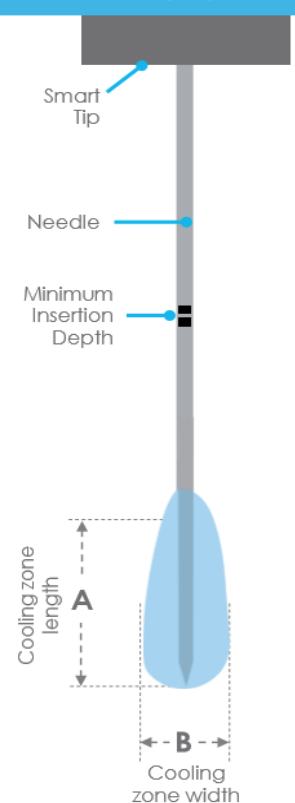

The diagram shows a vertical needle with a grey handle and a blue tip. Labels include 'Smart Tip' at the top, 'Needle' along the shaft, and 'Minimum Insertion Depth' indicated by a double-line marking. Below the needle, a blue oval represents the 'Cooling zone', with 'Cooling zone length' labeled as 'A' and 'Cooling zone width' labeled as 'B'.

h	mm (in)	
	A	B
STT0801	16.0 (0.63)	7.1 (0.28)

Dimensions are for information purposes only. They are based on 60-second cooling cycle performed in agarose gel. The ice ball size could vary based on anatomy/physiology of patients and should not affect the efficacy of treatment.

This document is provided as a supplement to the User Guide. Always refer to the User Guide for complete operating instructions, warnings and precautions.

! WARNING! To reduce likelihood of skin injury, insert needle at least 30mm, denoted by the double marking (labeled minimum insertion depth on the image) ■.

! CAUTION! Small bend radii may affect performance.

- Do not kink or permanently deform needle.
- 55mm minimum radius.

Procedure:

- Prep cycle not required for this tip type.
- Pre-piercing of the skin may make Smart Tip insertion easier.
- Insert needle to maximum insertion desired, then perform cooling cycle.

12607 Rev B

Smart Tip (3X8.5 mm Sharp, 27 Gauge)

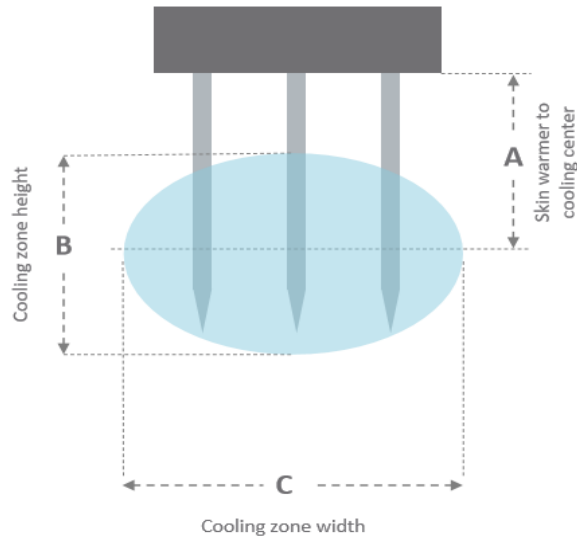
User Guide Addendum
Smart Tip (3x8.5mm Sharp, 27 Gauge)iovera[®]

h	A mm (in)	B mm (in)	C mm (in)
STT0309	6.3 (0.25)	6.5 (0.26)	8.0 (0.31)

Dimensions are for information purposes only. They are based on 33-second cooling cycle performed in agarose gel. The ice ball size could vary based on anatomy/physiology of patients and should not affect the efficacy of treatment.

This document is provided as a supplement to the User Guide. Always refer to the User Guide for complete operating instructions, warnings and precautions.

Procedure:

- Prep cycle **not required** for this tip type.
- Insert needle to maximum insertion desired, then perform cooling cycle.



WARNING! To reduce likelihood of skin injury, skin warmer must be pressed against the skin when the needle is inserted before running a treatment cycle.



WARNING! Needle may contact bone in low BMI patients. Patient anatomy should be assessed prior to tip selection.

12440 Rev C

Manufacturer

Pacira Pharmaceuticals Inc.



A subsidiary of Pacira BioSciences, Inc.

46400 Fremont Blvd

Fremont, CA 94538 USA

Telephone: 510.933.1500

www.iovera.com



Authorized Representative

Emergo Europe

Prinsessegracht 20

2514 AP The Hague

The Netherlands

EmergoEurope.eu